



KOLEKCIJA  
2020





Since the establishment in 1994, we have set standards, from which we still do not deviate. These are high aesthetic values, modern design and uncompromising quality. The skillful hands of our craftsmen shape the material and turn the ideas into reality. Cooperation with renowned European and domestic designers, the selection of quality materials and the passion that we bring into each product has contributed to Atlas having its place in the furniture world. From a small handcraft workshop with only three workers, Atlas has grown into a modern company with 160 workers thanks to big effort, hard-work and commitment. The demands of the contemporary market pose new challenges before us and we are ready to respond to them.

Our products are characterized by the use of cutting-edge materials and modern technologies, as well as perfect comfort, all for the sake of satisfaction of our customers. Hand-painted, high-quality Italian leather, best fabrics and feathers, modern motorized relaxing mechanisms, high-elastic foam, quality wooden construction made of beech massive, are carefully packed into a product that ranks with the products of the world's most famous furniture brands.

Od osnivanja 1994. godine postavili smo standarde od kojih i dalje ne odstupamo. To su visoke estetske vrednosti, moderan dizajn i beskompromisan kvalitet. Vešte ruke naših majstora oblikuju materijal i ideje pretvaraju u stvarnost. Saradnja sa poznatim evropskim i domaćim dizajnerima, odabir kvalitetnih materijala i strast koju unosimo u svaki proizvod doprinela je da Atlas danas ima svoje mesto u svetu nameštaja. Trudom, radom i zalaganjem Atlas je od zanatske radionice sa tri zaposlena prerastao u moderno preduzeće sa 160 radnika. Zahtevi savremenog tržišta postavljaju pred nas nove izazove i mi smo spremni da na njih odgovorimo.

Naše proizvode karakteriše upotreba vrhunskih materijala i modernih tehnologija, kao i savršena udobnost, a sve u cilju zadovoljstva naših kupaca. Rukom bojena, kvalitetna italijanska koža, najbolji štofovi, perje, savremeni motorizovani relax mehanizmi, viskoelastični sunđer, kvalitetna drvena konstrukcija izrađena od bukovog masiva, pažljivo su upakovani u proizvod koji je u rangu sa proizvodima najpoznatijih svetskih brendova.



# CONTENT SADRŽAJ

<b>SOFAS   GARNITURE</b>	<b>5</b>
ADELE	7
KENT	11
MADRID	15
MILANO	19
ONIX	23
OXFORD	27
<b>SOFA BEDS</b>	
<b>GARNITURE NA RAZVLAČENJE</b>	<b>31</b>
ADRIA	33
TERRA	37
PANAMA	134
PARMA	138
<b>ARMCHAIRS AND OTTOMANS</b>	
<b>FOTELJE I TABUREI</b>	<b>41</b>
HUG	43
GEA	44
<b>SIDEBARDS</b>	
<b>KOMODE</b>	<b>45</b>
OMNIA LUX	
NK- 120	47
OMNIA LUX	
TK-140	48
OMNIA LUX	
NK-180	49
<b>COFFEE TABLES</b>	
<b>KLUB STOLOVI</b>	<b>51</b>
CT-18	52
<b>TECNICAL SPECIFICATIONS</b>	
<b>TEHNIČKE SPECIFIKACIJE</b>	<b>53</b>

SOFAS







ADELE









| KENT









MADRID









MILANO









| ONIX









# | OXFORD







# SOFA BEDS







ADRIA



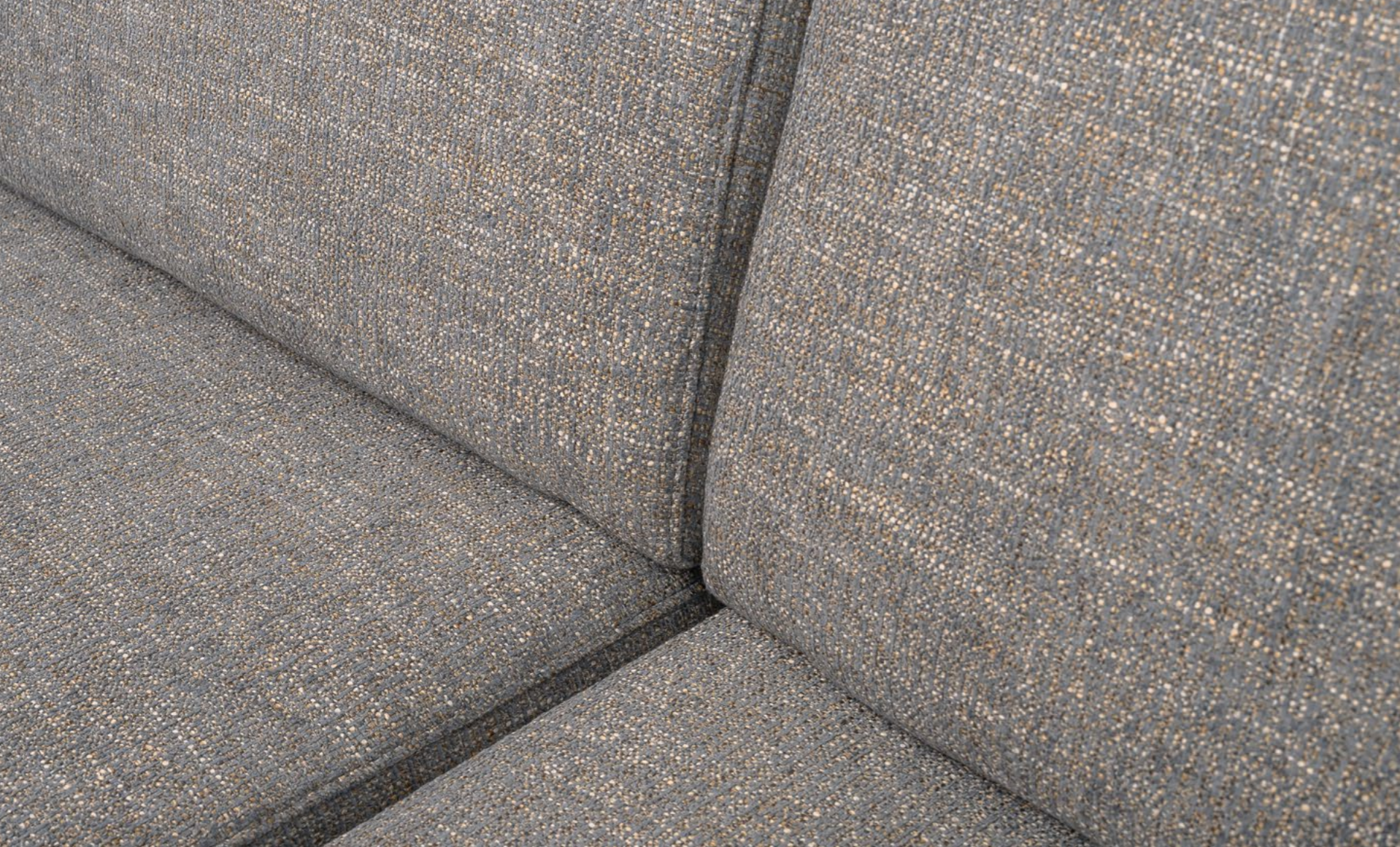





TERRA







# ARMCHAIRS AND OTTOMANS







# GEA

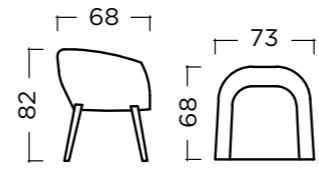

# HUG

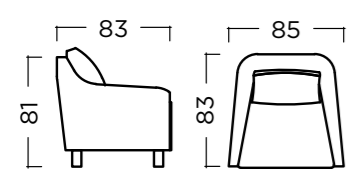



# SIDEBOARDS





# OMNIA LUX - NK 120

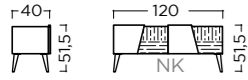

# OMNIA LUX - TK 140

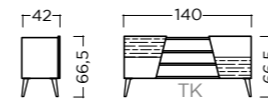



# OMNIA LUX - NK 180

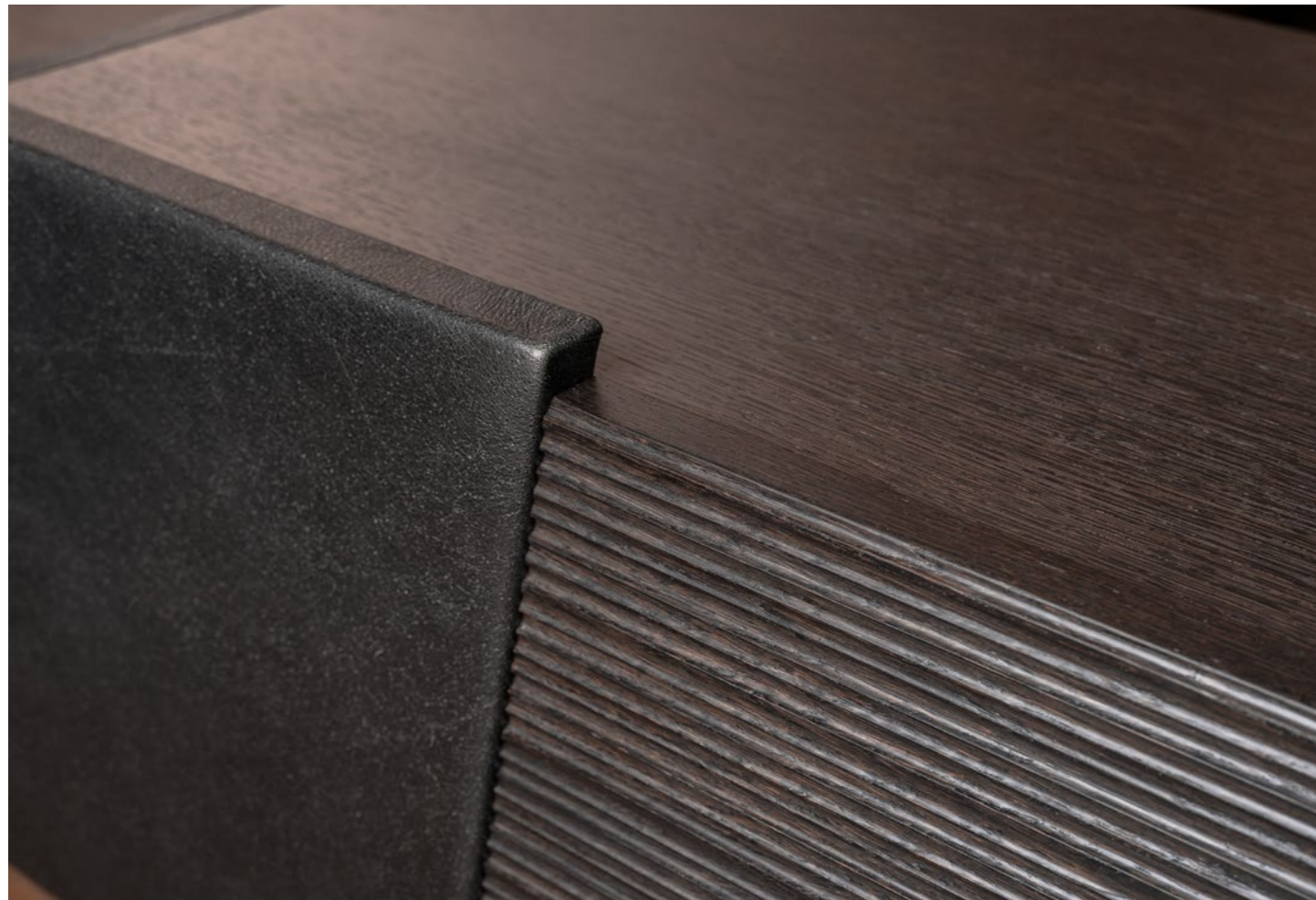
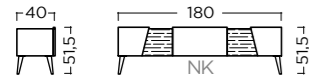



# COFFEE TABLES



CT-18

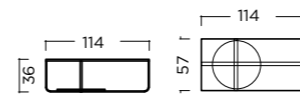



# TECHNICAL SPECIFICATIONS

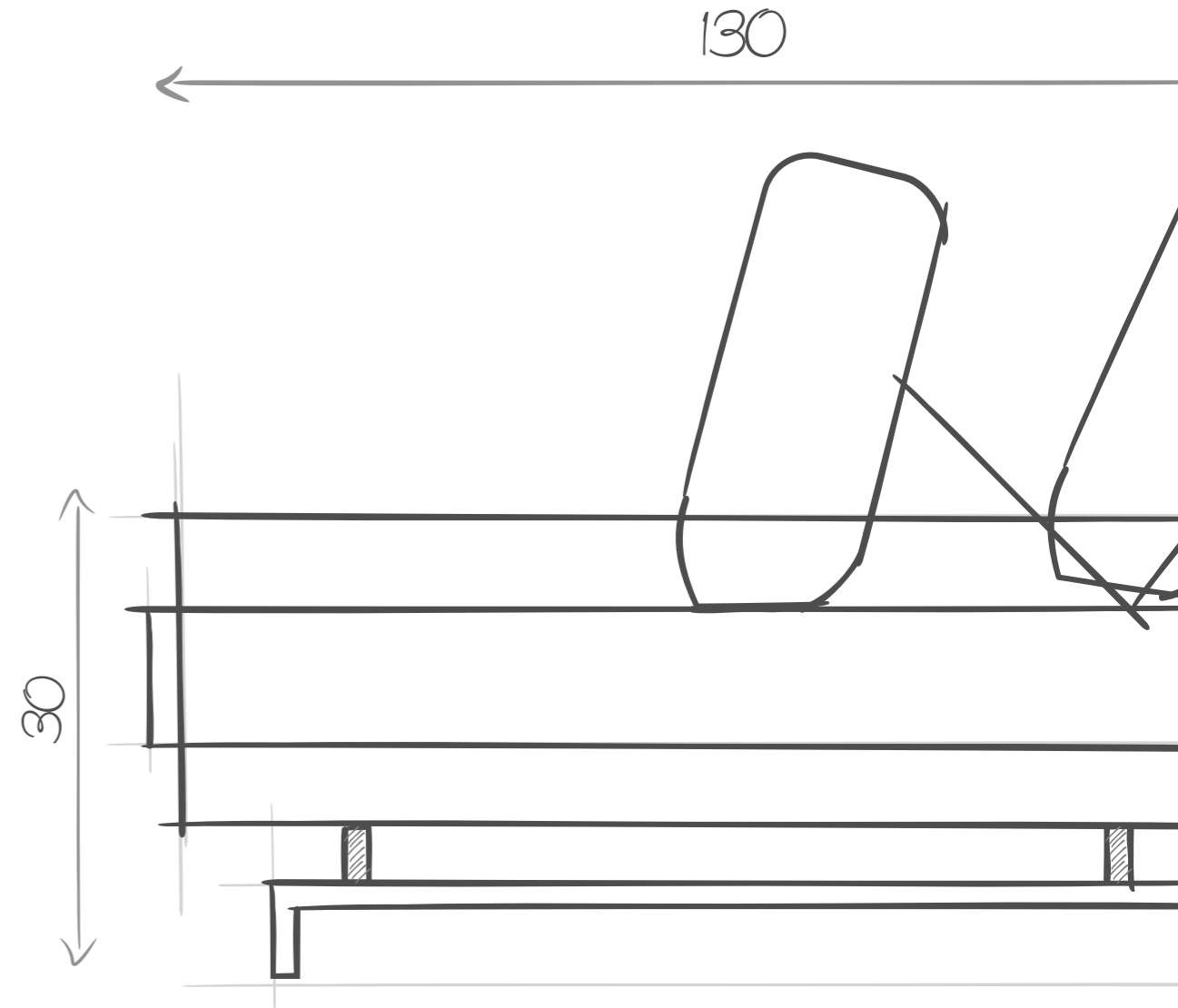



## ADELE

**KONSTRUKCIJA** Noseći elementi od bukovog masiva ojačani pločastim panelima  
**OSLANJANJE** Ukrštene elastične trake širine 7 cm  
**SEDIŠTE** HR pena 35/36, memory pena, prirodno perije sa silikonskim kuglicama  
**NASLON** HR pena 35/36, punjenje memory pena, prirodno perije sa silikonskim kuglicama  
**NOGICE** Metalna - boja po RAL karti, INOX

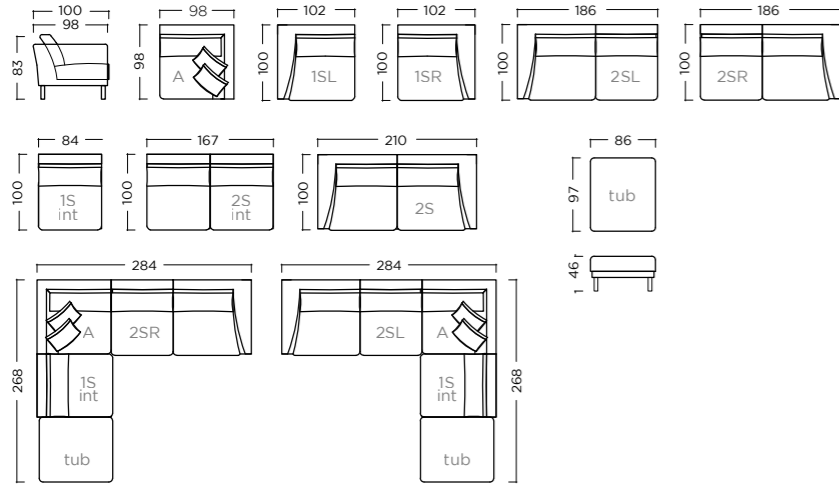

## KENT

**KONSTRUKCIJA** Noseći elementi od bukovog masiva ojačani pločastim panelima  
**OSLANJANJE** Ukrštene elastične trake širine 7 cm  
**SEDIŠTE** Visokoelastična poliuretanska HR pena 35/36 i HR pena 35/30 i prirodno perja sa silikonskim kuglicama  
**NASLON** Silikonske kuglice  
**NOGICE** Drveni ram - bajc, poliuretanski lak, pokrivena poliuretanska boja po RAL karti, efekat paljenog drveta

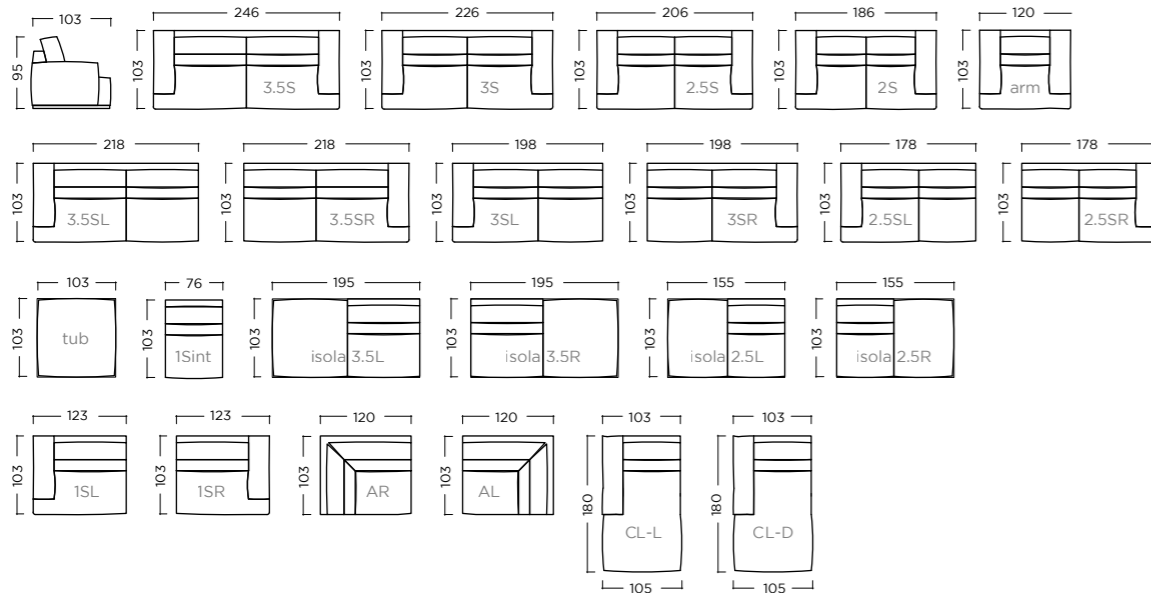

## MADRID

**KONSTRUKCIJA** Noseći elementi od bukovog masiva ojačani pločastim panelima  
**OSLANJANJE** Ukrštene elastične trake širine 7 cm  
**SEDIŠTE** Visokoelastične poliuretanske HR pene 35/30, N pene 25/38 i 18/30  
**NASLON** Visokoelastične poliuretanske HR pene 35/30, N pene 25/38 i 18/30  
**NOGICE** Metalna - boja po RAL karti

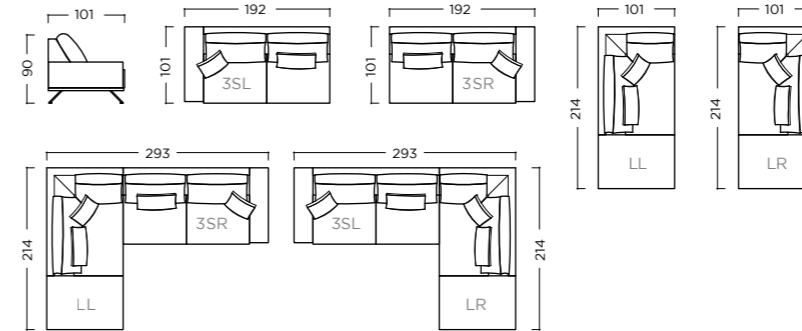

## MILANO

**KONSTRUKCIJA** Noseći elementi od bukovog masiva ojačani pločastim panelima  
**OSLANJANJE** Ukrštene elastične trake širine 7 cm  
**SEDIŠTE** HR pena 35/36, memory pena, prirodno perije sa silikonskim kuglicama  
**NASLON** HR pena 35/36, punjenje memory pena, prirodno perije sa silikonskim kuglicama  
**NOGICE** Metalna - boja po RAL karti, INOX

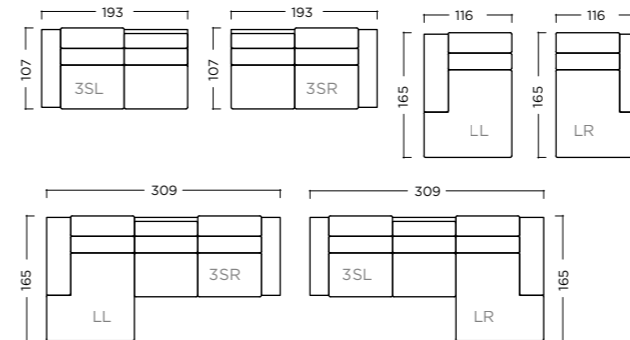



## ONIX

**KONSTRUKCIJA** Nosači elementi od bukovog masiva ojačani pločastim panelima  
**OSLANJANJE** Ukrštene elastične trake širine 7 cm  
**SEDIŠTE** Visokoelastične poliuretanske HR pene 35/36, HR pene 35/30 i prirodnog perja sa silikonskih kuglica  
**NASLON** Visokoelastične poliuretanske L pene 25/15 i silikonskih kuglica  
**NOGICE** Metalna-inox  
**OPCIJE** Mehanizam za spavanje

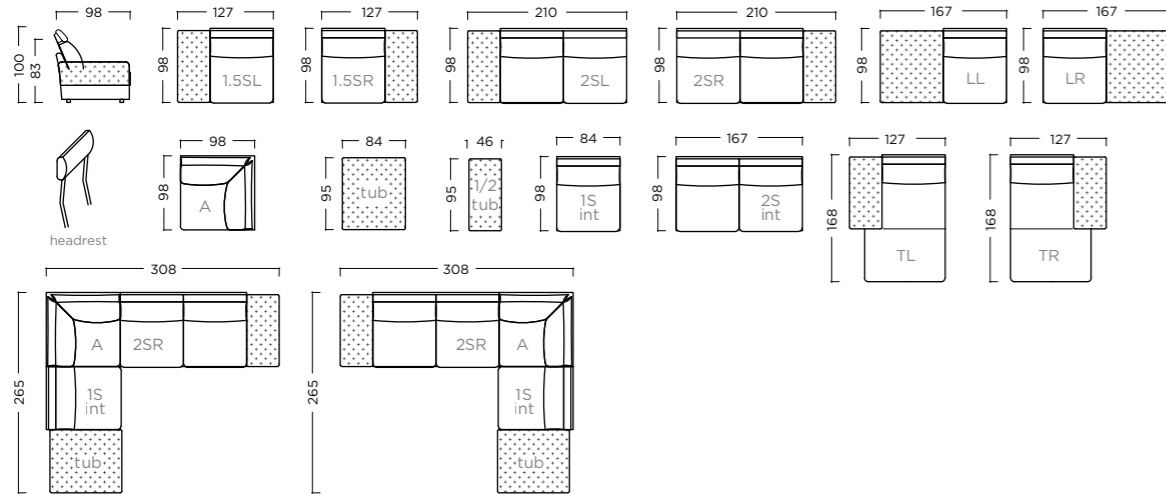

## SOFA BEDS

### ADRIA

**KONSTRUKCIJA** Nosači elementi od bukovog masiva ojačani pločastim panelima  
**OSLANJANJE** Ukrštene elastične trake širine 7 cm / mehanizam za spavanje  
**SEDIŠTE** Visokoelastična poliuretanska HR pena 35/36  
**NASLON** Visokoelastična poliuretanska L pena 25/15  
**NOGICE** Metalne - boja po RAL karti  
**OPCIJE** Mehanizam za spavanje

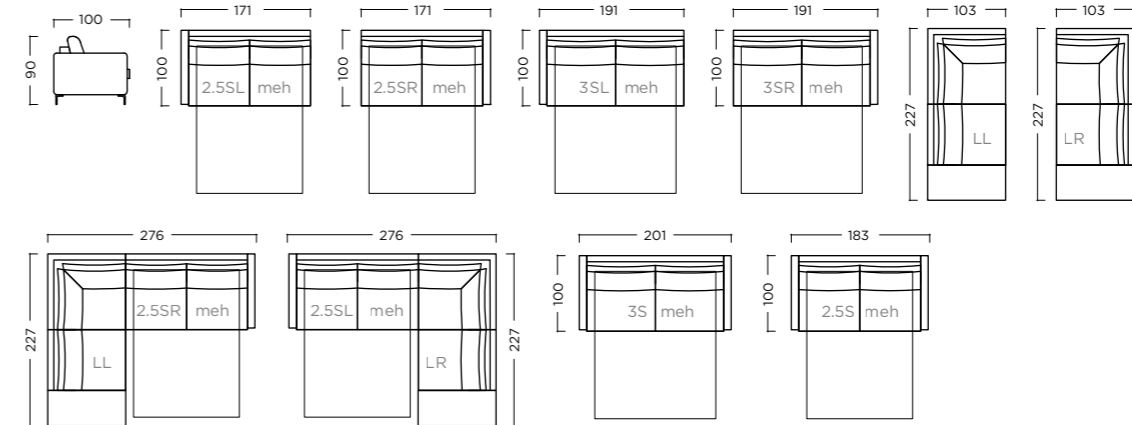

## OXFORD

**KONSTRUKCIJA** Nosači elementi od bukovog masiva ojačani pločastim panelima  
**OSLANJANJE** Ukrštene elastične trake širine 7 cm  
**SEDIŠTE** Visoko elastična poliuretanska HR pena 35/30 i HR pena 35/36, u konflinskoj navlaci  
**NASLON** Visokoelastične poliuretanske L pene 25/15, u konflinskoj navlaci  
**NOGICE** Metalna stopa- boja po RAL karti  
**OPCIJE** Mehanizam za korigovanje glavonaslona

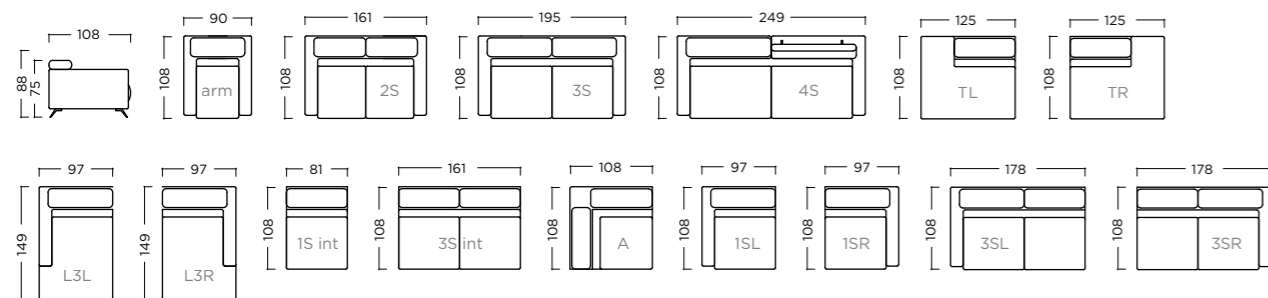

## TERRA

**KONSTRUKCIJA** Nosači elementi od bukovog masiva ojačani pločastim panelima  
**OSLANJANJE** Mehanizam  
**SEDIŠTE** Visokoelastična poliuretanska HR pena 35/36, u konflinskoj navlaci  
**NASLON** Visokoelastične poliuretanske M pene 18/15, u konflinskoj navlaci  
**NOGICE** Mehanizamske  
**OPCIJE** Mehanizam za spavanje

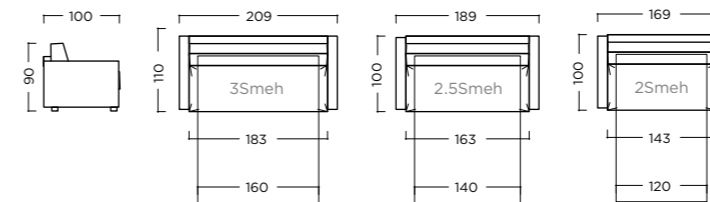



**ATLAS d.o.o.**

Užice, Serbia

tel: +381 (0) 31 533 555

email: atlas@atlassofas.eu

The catalogue is made in accordance with the information at the time of printing. Deviations of 3 % in product dimensions are possible. We are not responsible for any printing errors, subsequent product changes or image fidelity.

All rights reserved.  
©2019 Atlas.d.o.o





